

# ART DECO HEATED TOWEL RAIL

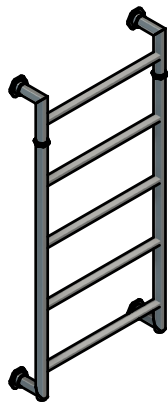

LIVINGHOUSE.CO.UK  
 TEL: 01722 415000  
 EMAIL: SALES@LIVINGHOUSE.CO.UK

Dept.	Technical reference	Approved by	
		Document type	Document status
		Title <b>1000x500mm</b>	DWG No.
		Rev.	Date of issue
		Sheet <b>1/1</b>	

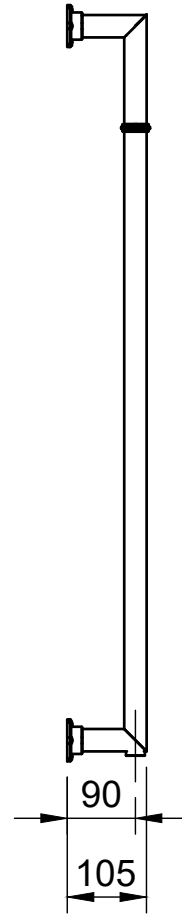
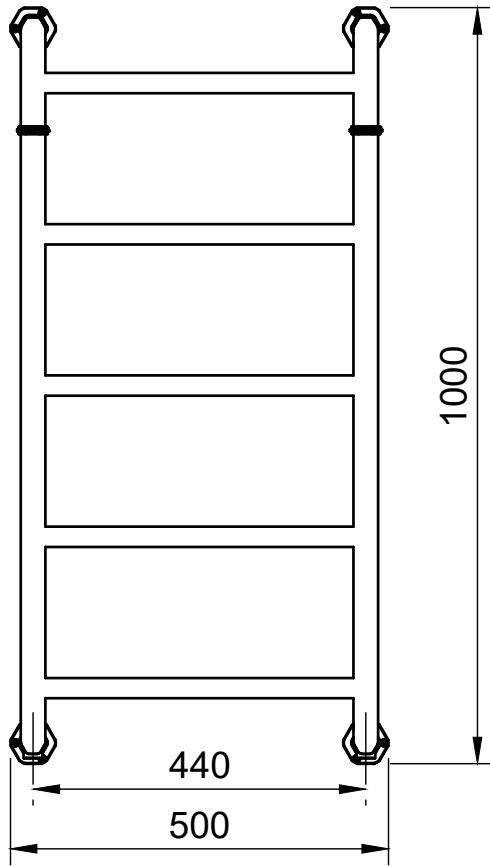
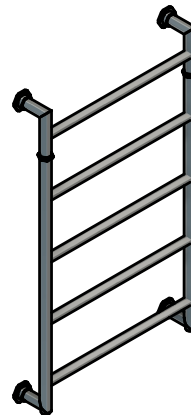
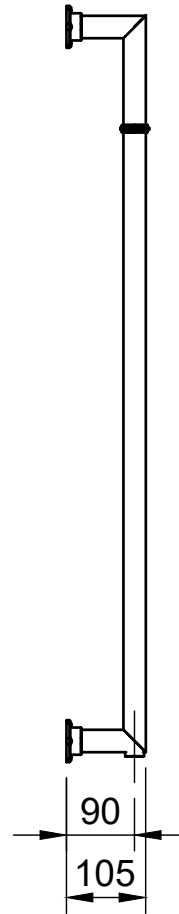
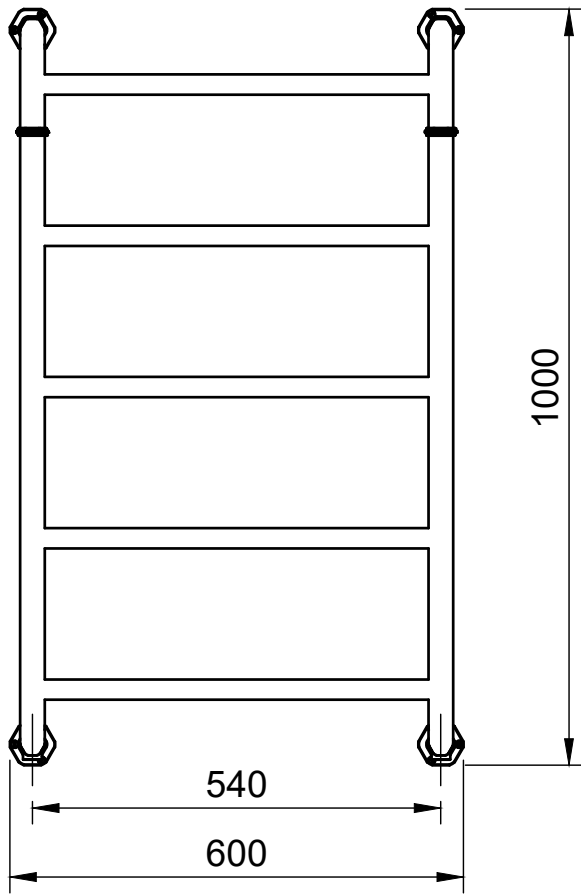

Dept.	Technical reference	Approved by	
		Document type	Document status
		Title <b>1000x600</b>	DWG No.
		Rev.	Date of issue
		Sheet <b>1/1</b>	

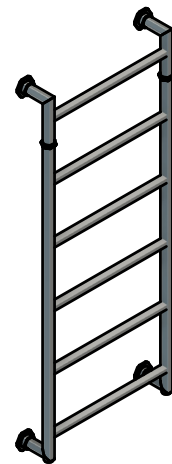
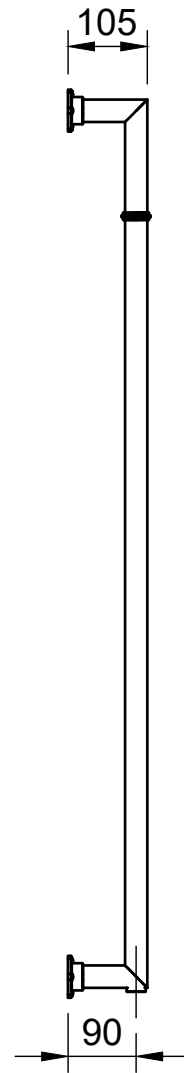
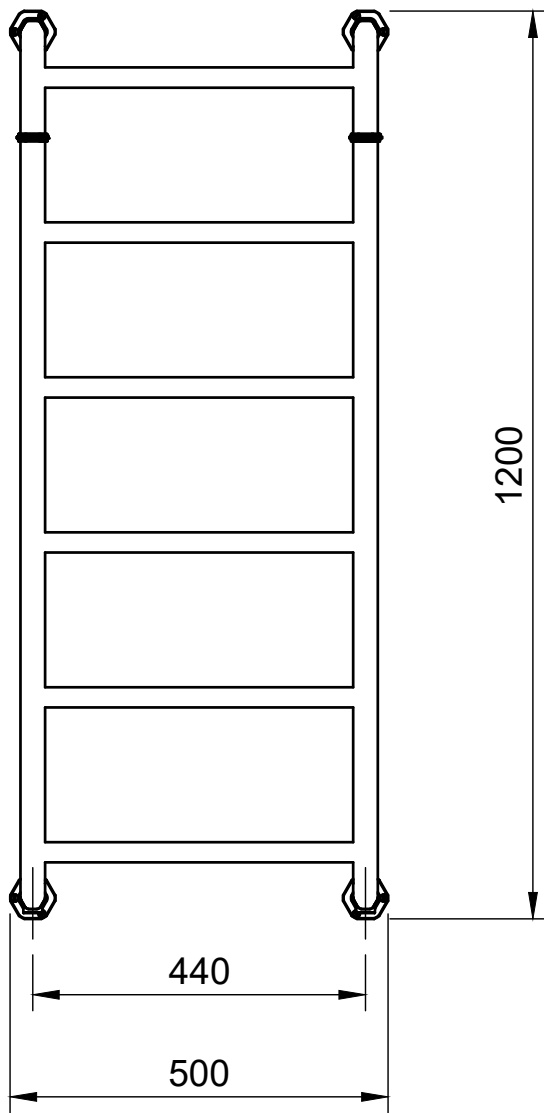

Dept.	Technical reference	Approved by	
		Document type	Document status
		Title <b>1200x500</b>	DWG No.
		Rev.	Date of issue
		Sheet <b>1/1</b>	

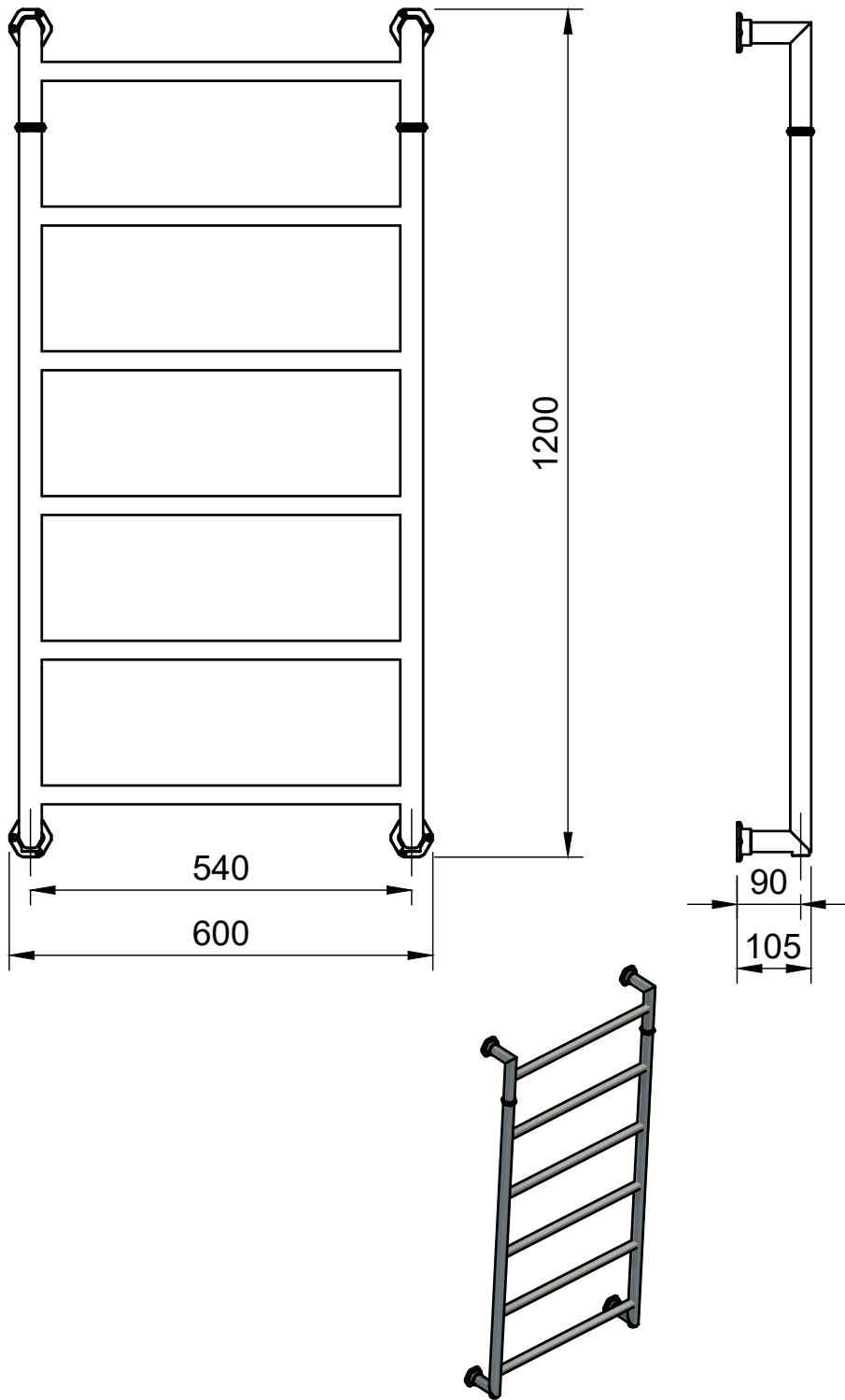

Dept.	Technical reference	Approved by	
		Document type	Document status
		Title <b>1200x600</b>	DWG No.
		Rev.	Date of issue
		Sheet <b>1/1</b>	

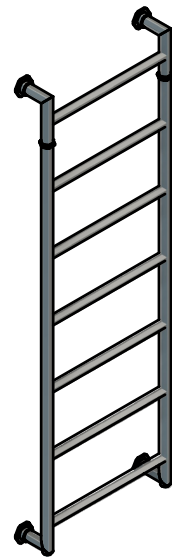
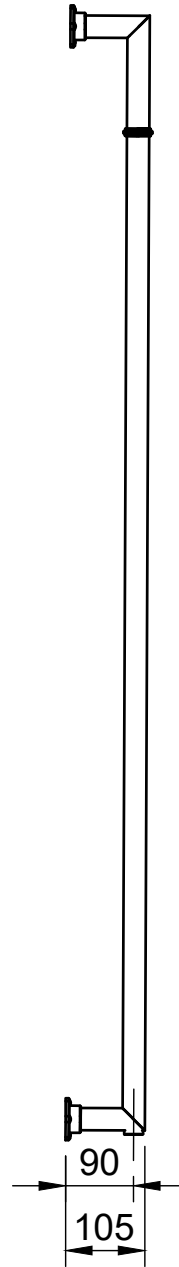
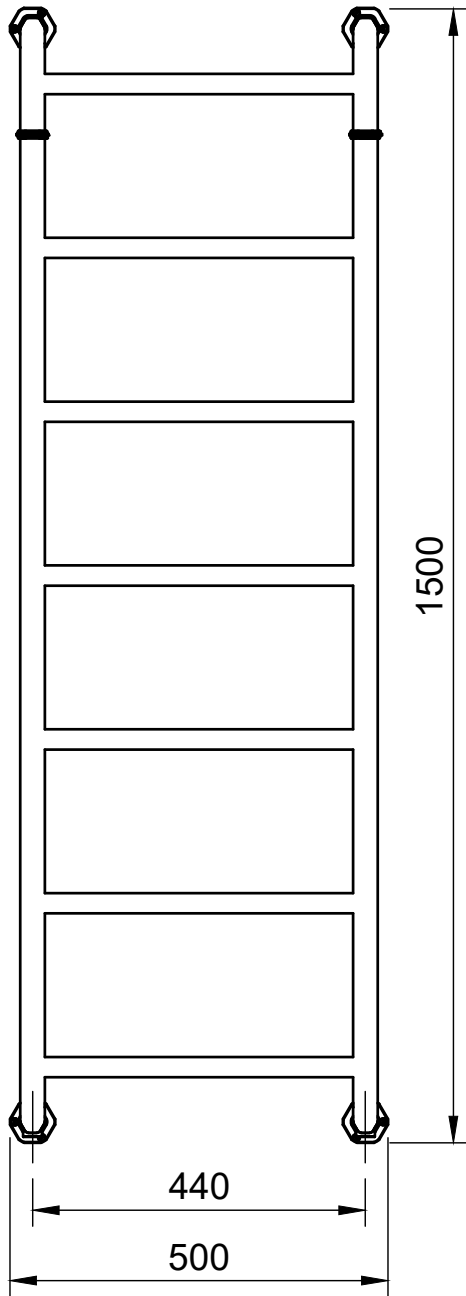

Dept.	Technical reference	Approved by	
		Document type	Document status
		Title <b>1500x500mm</b>	DWG No.
		Rev.	Date of issue
		Sheet <b>1/1</b>	

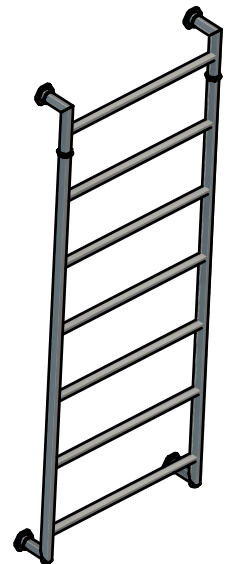
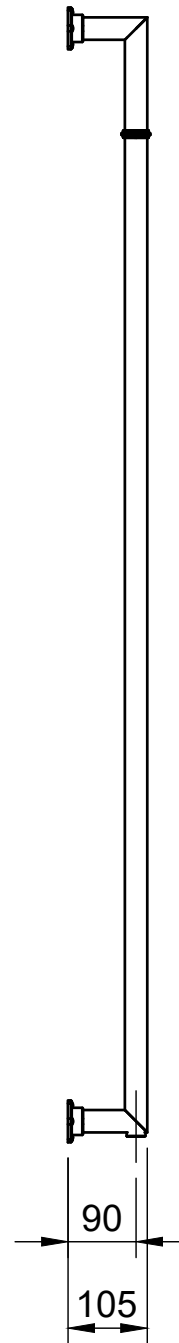
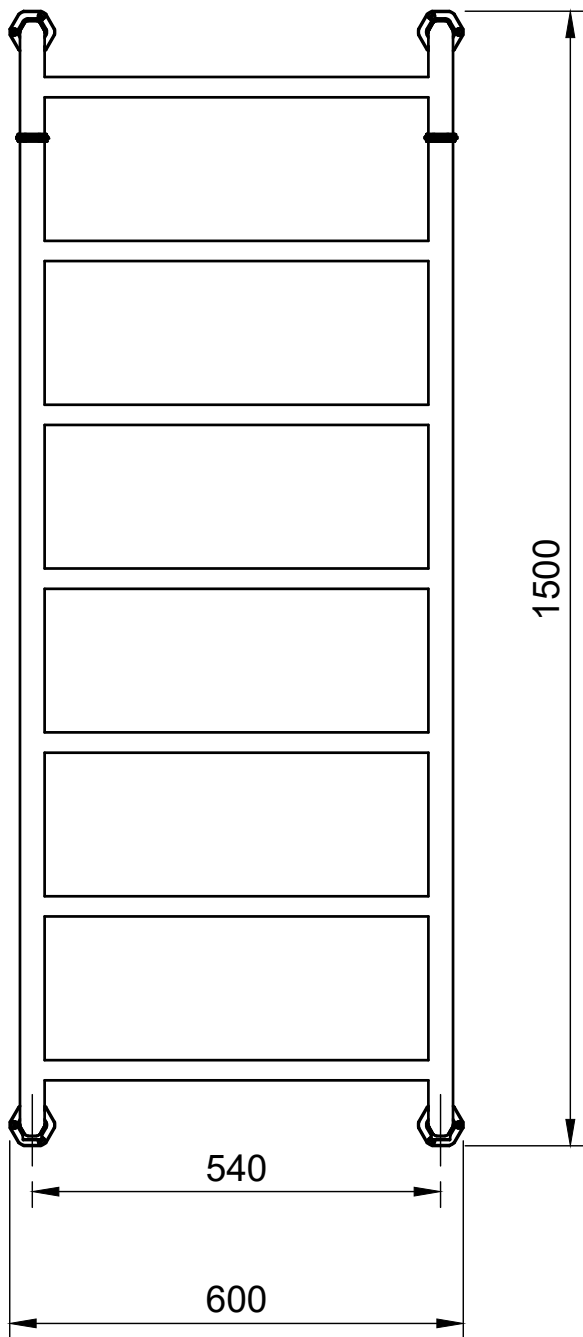

Dept.	Technical reference	Approved by	
		Document type	Document status
		Title <b>1500x600</b>	DWG No.
		Rev.	Date of issue
		Sheet <b>1/1</b>	