

# XXL CEILING MOUNTED SHOWER HEAD (75X)



LIVINGHOUSE.CO.UK

TEL: 01722 415000

EMAIL: SALES@LIVINGHOUSE.CO.UK

---

## INSTALLATION INSTRUCTIONS

FIG.1

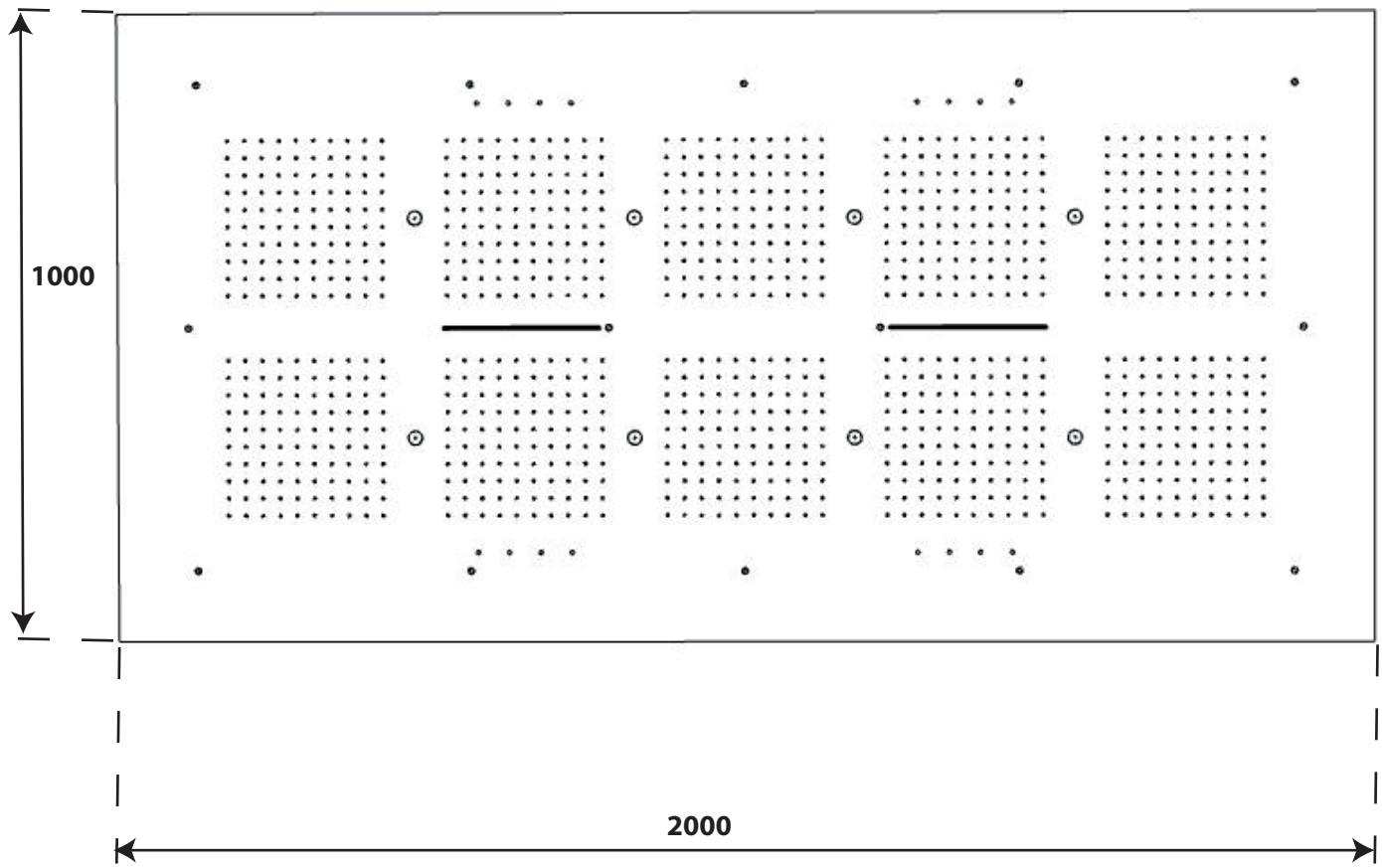
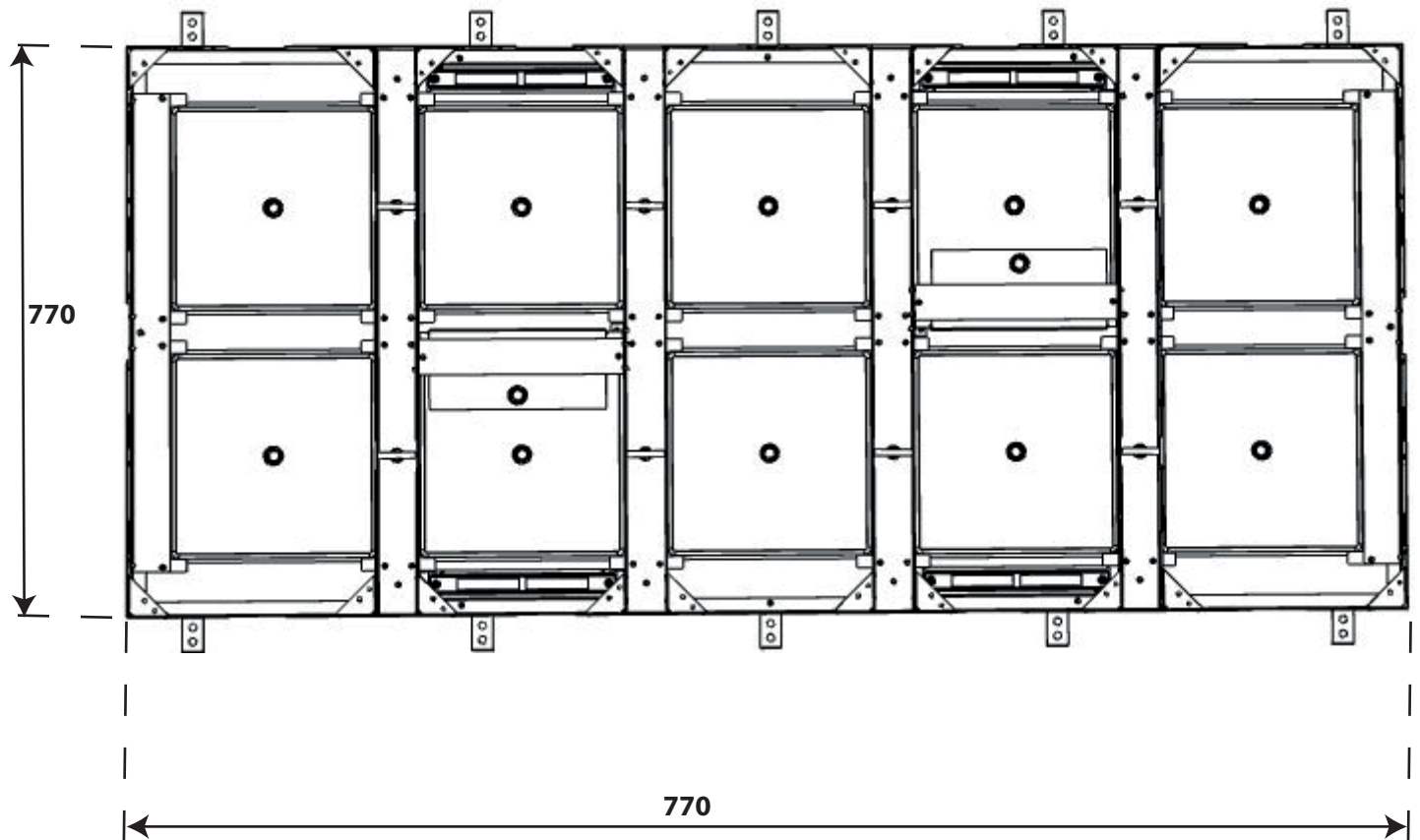
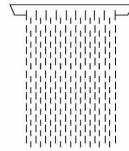
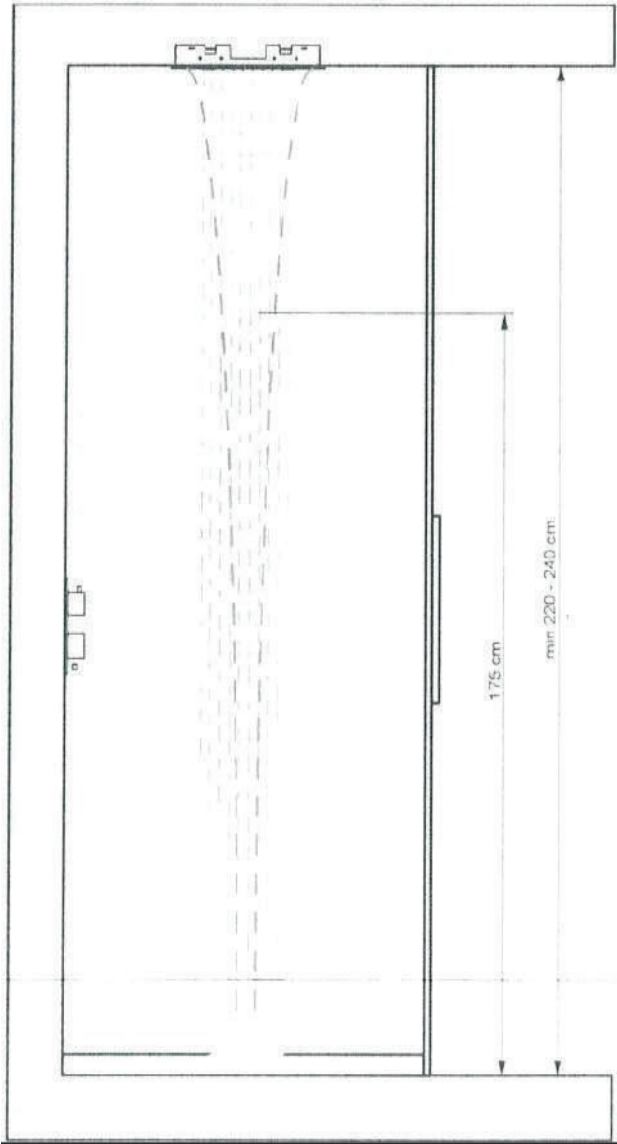

FIG.2





10 showerheads, they are fed in pairs and each have a limiter of 15 lt/min.  
For optimal operation, they need 3 Bar pressure (max 6 Bar) and at least 90 lt/min of total flow rate.



2 central waterfalls feed together with each other. For proper operation, they need 2,5 Bar of pressure and at least 18 lt/min of total flow rate.

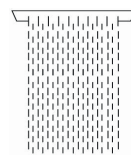

Correct temperature 38°/40°.  
Max temperature 65°/70°.

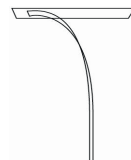
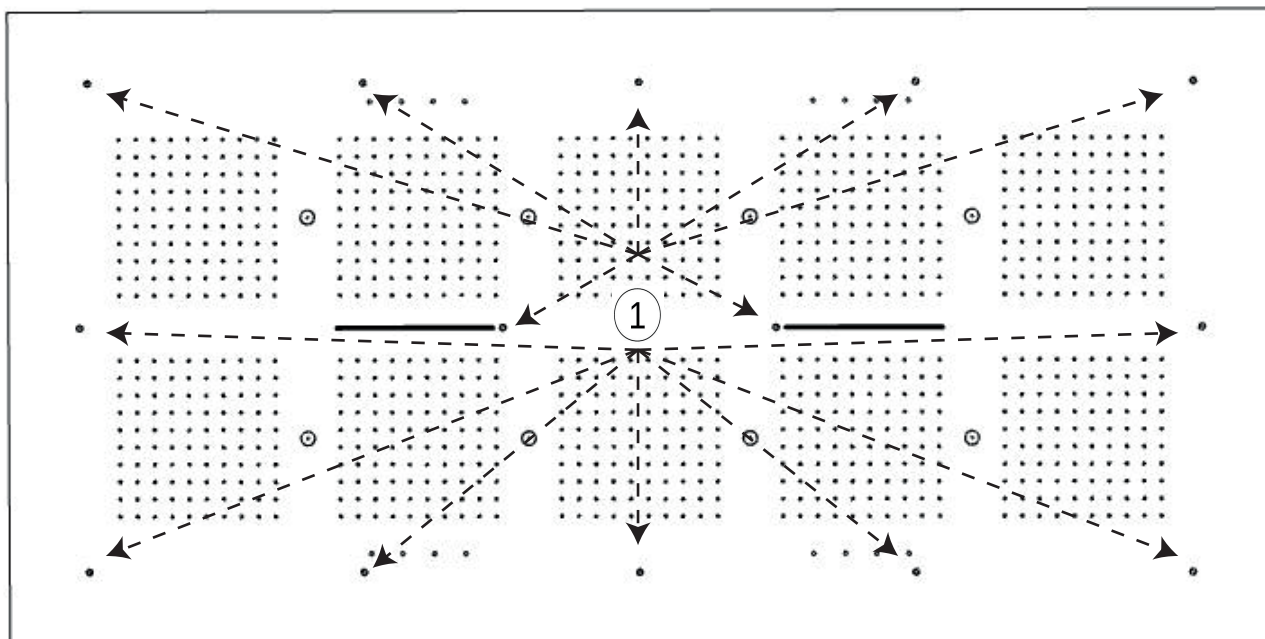
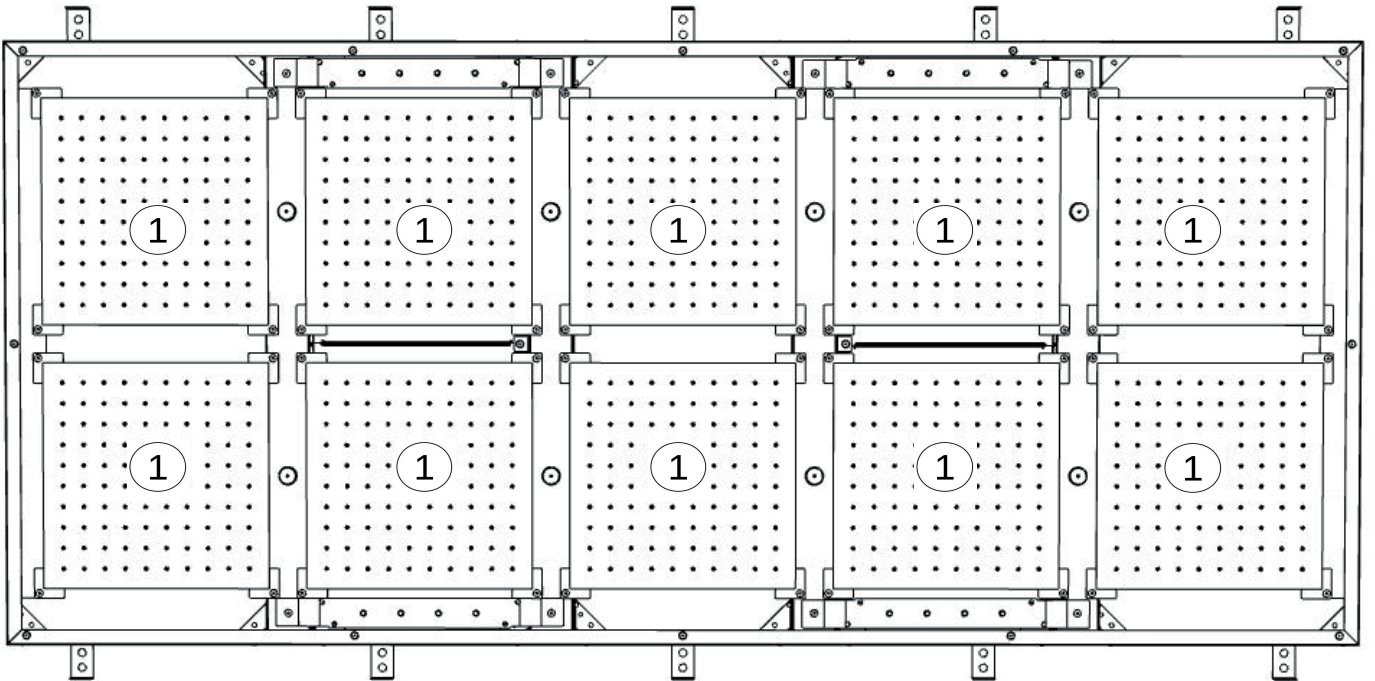

FIG.3



After having prepared the seat for the frame of your new showerhead, you need to remove some parts of it. These operations shall only be performed for installation and for eventual inspections. Without removing the blue film, unscrew the 13 screws (1) using the supplied Allen key. Put the aesthetic cover plate aside from the work area to avoid damaging it.

FIG.4



With the provided Allen Key, unmount the 10 rain elements (1) by unscrewing the 40 screw (four for each element).

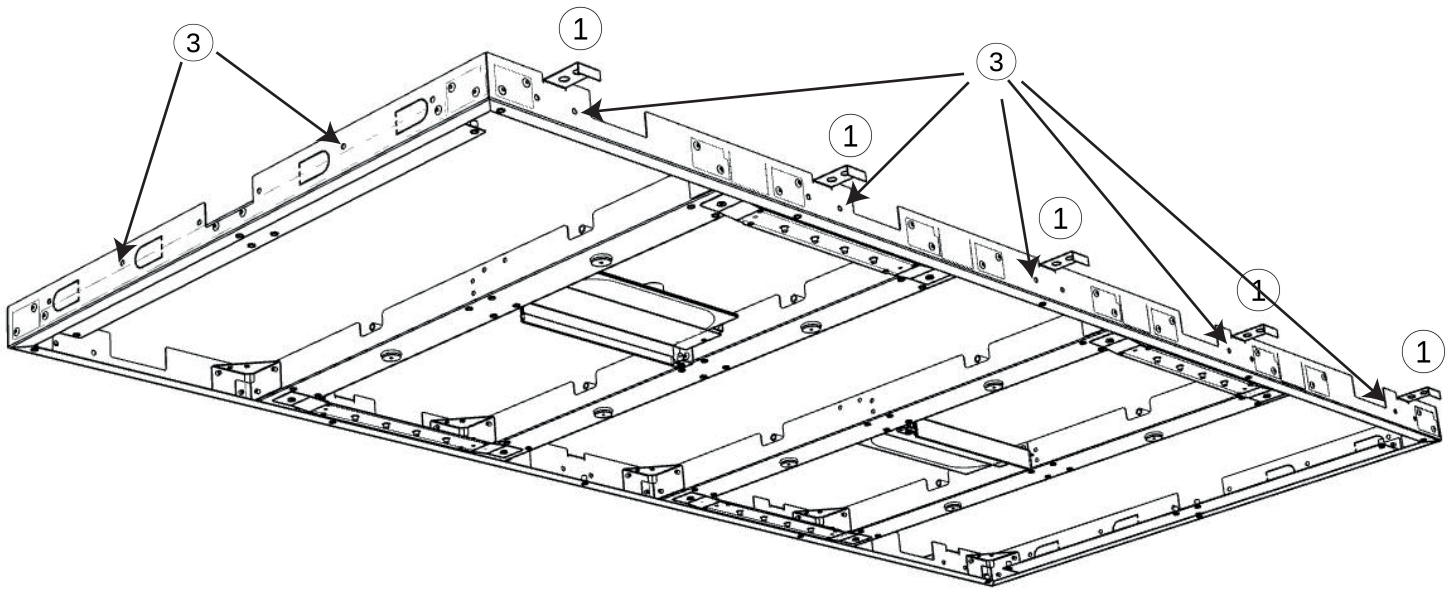

For a correct installation of the multifunctional showerhead (Fig.1 and Fig.2), it is necessary to securely fix the support frame to the ceiling frame (or to the false ceiling frame) through the fins (1) and/or self-threading screws through slots (3).

A correct placement of the frame shall have the the water outlets at about the center of it, and the lower edge of the frame must be flush with the external surface of the ceiling (Fig.5)

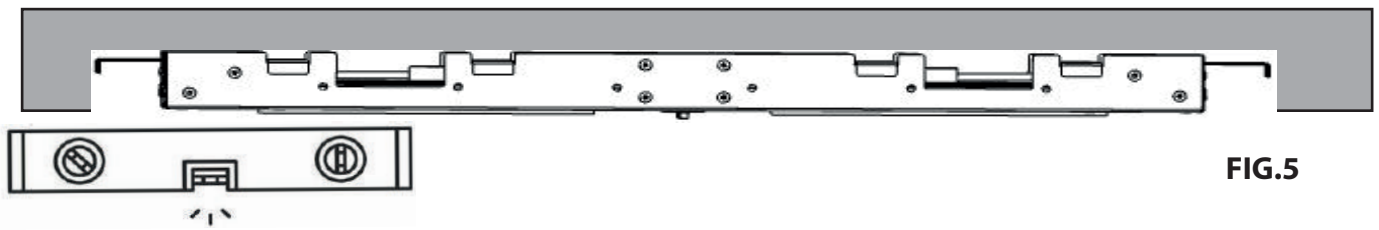
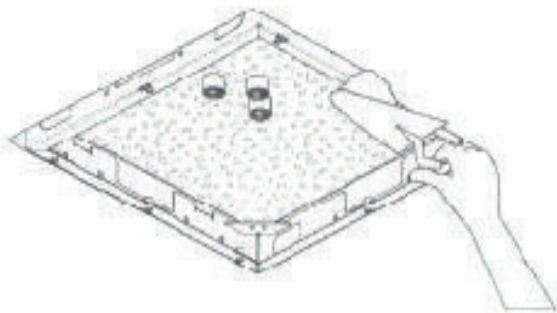
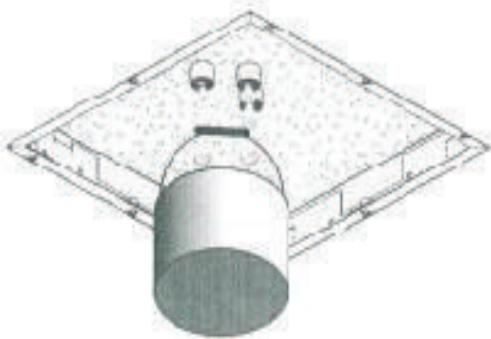

FIG.5

Before fixing the frame, make sure that it is flush with the ceiling.



Seal any space between frame and ceiling.



Before connecting the showerhead, make sure the water system is empty and clean.

Prior to re-assembling the parts when installing the frame you shall install the electrical connections for the chromotherapy feature (if present in the showerhead) by following the specific instruction provided. This operation should be performed by a specialised professional. After the installation of the electrical connections proceed to set up the water supply of the joined waterfalls and then the rain elements (1) as seen in Fig. 4, also arranged in couples.

After this step you can fasten the screws (2) in Fig. 4.

Now you are ready to re-assemble the aesthetic cover plate seen in Fig. 3 by tightening screws (1) as seen in Fig. 3



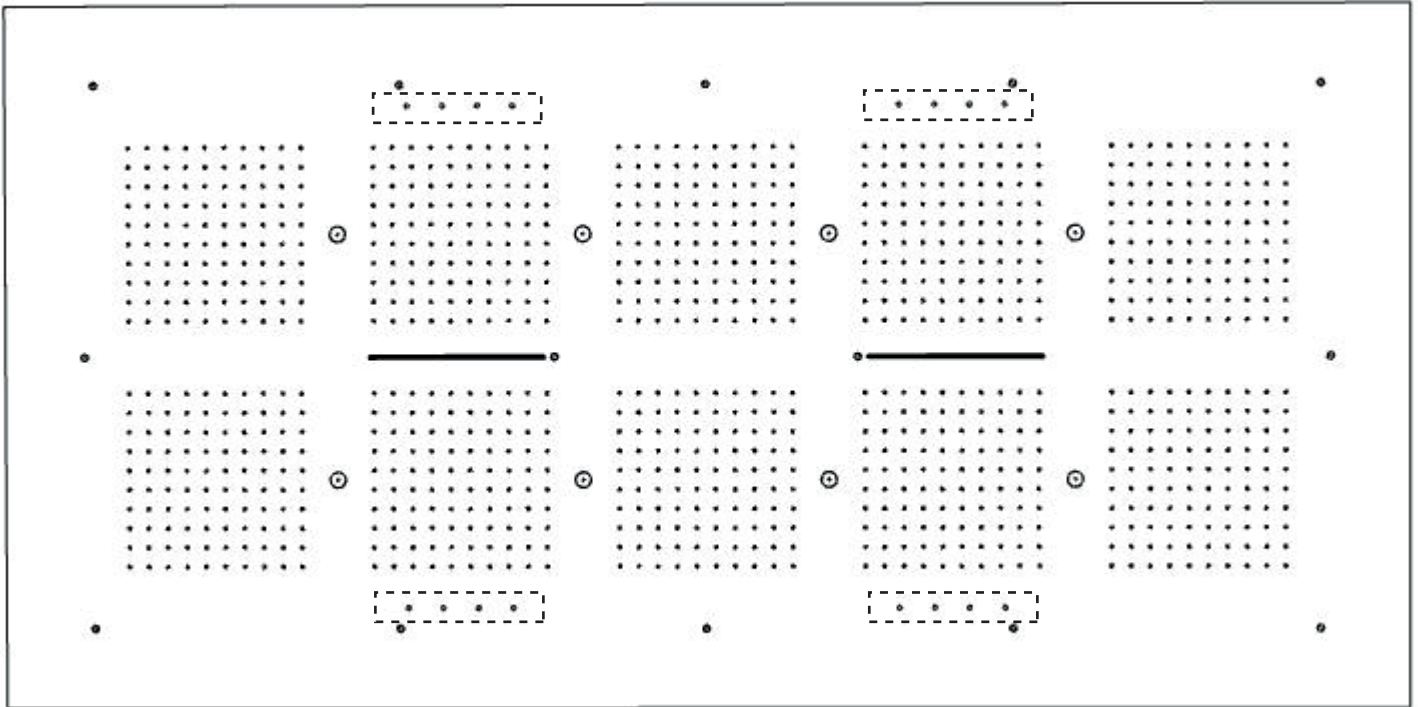

### **IN-WALL CHROMOTHERAPY CONTROL**

According to the law, a qualified person must properly install the device.

The device should not be used by people (including children) who have not received the instruction about the use of the device for guarantee his safety.

Children must be supervised to ensure that they do not play the device.

Remove the voltage before making all operations.

Install the device in the right position (pag.10) A Zone according to the safety distance to IEC Regulations.

Verify the capacity of hydraulic system before making the electrical connection.

The electrical cables and spare parts must be replaced by a qualified person. The manufacturer disclaims all liability for damage which may result as a consequence of improper use contrary to the instructions.

## Electrical predisposition

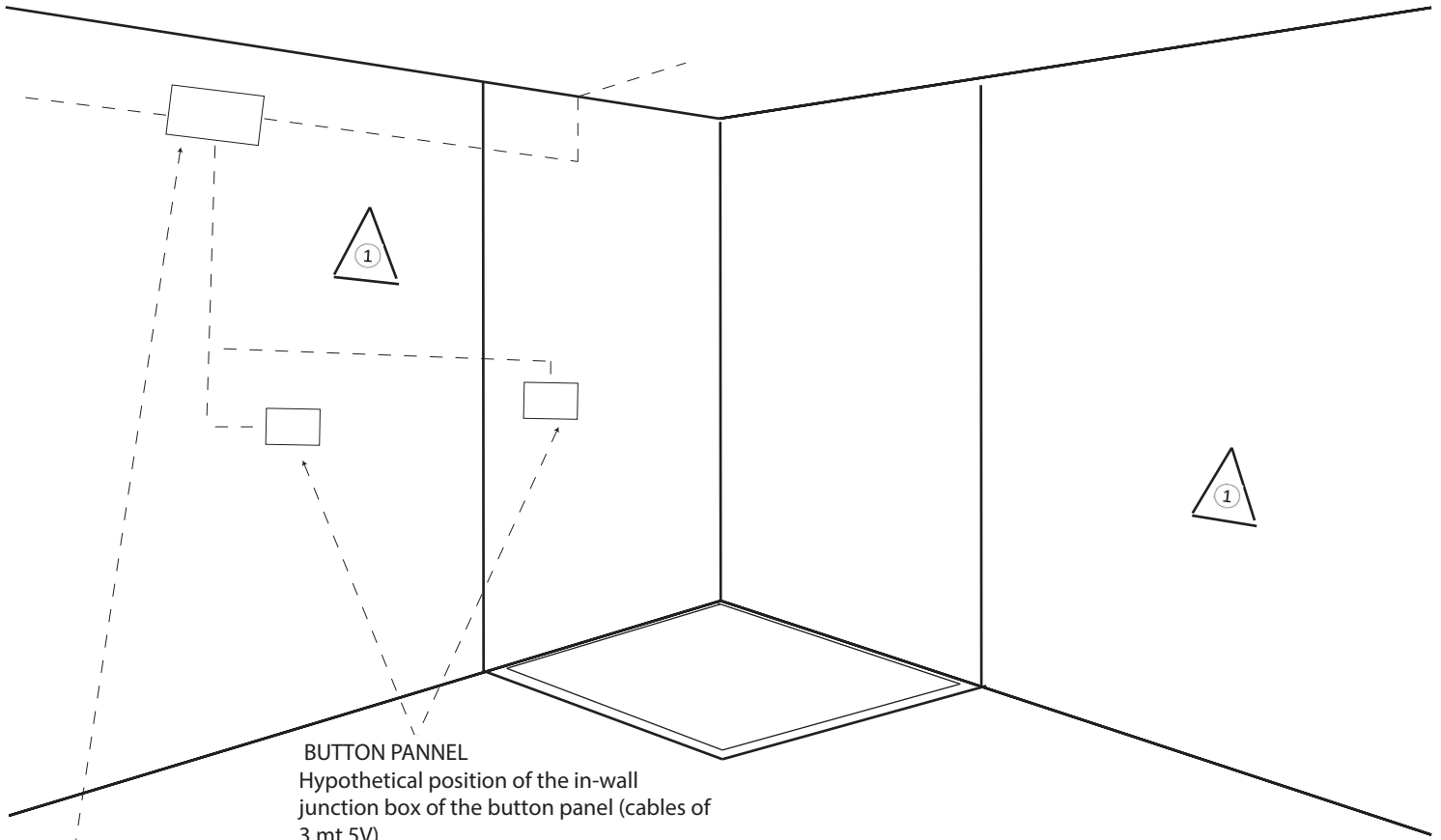

Output  
5 Watt



## Electrical connection

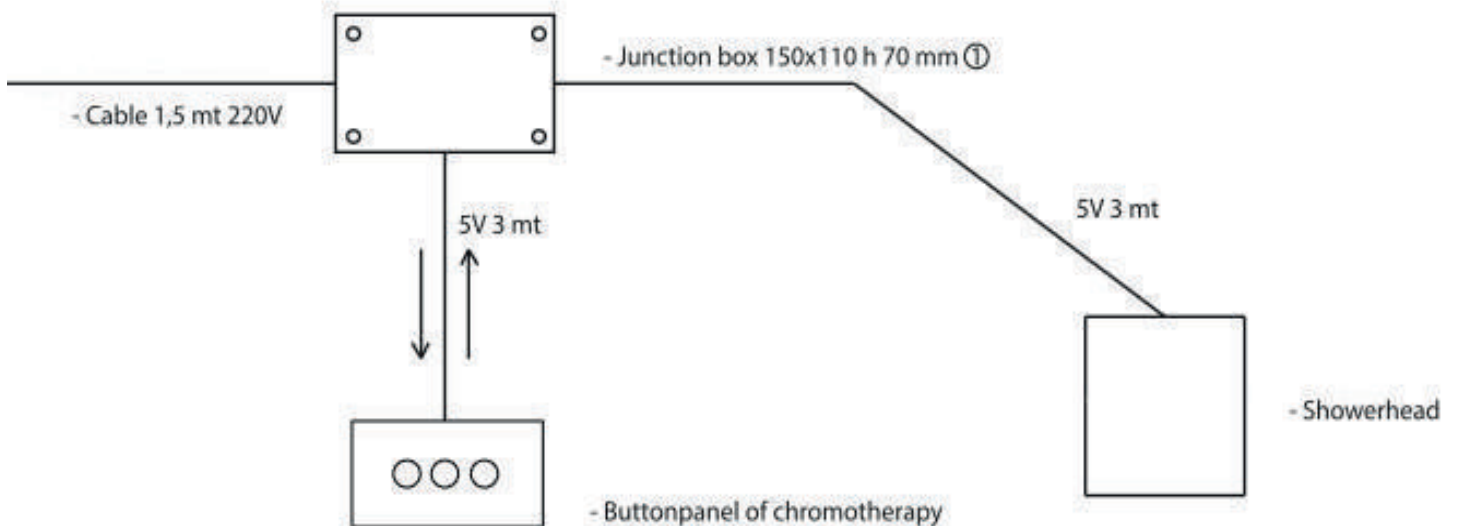

# Buttonpanel of chromotherapy

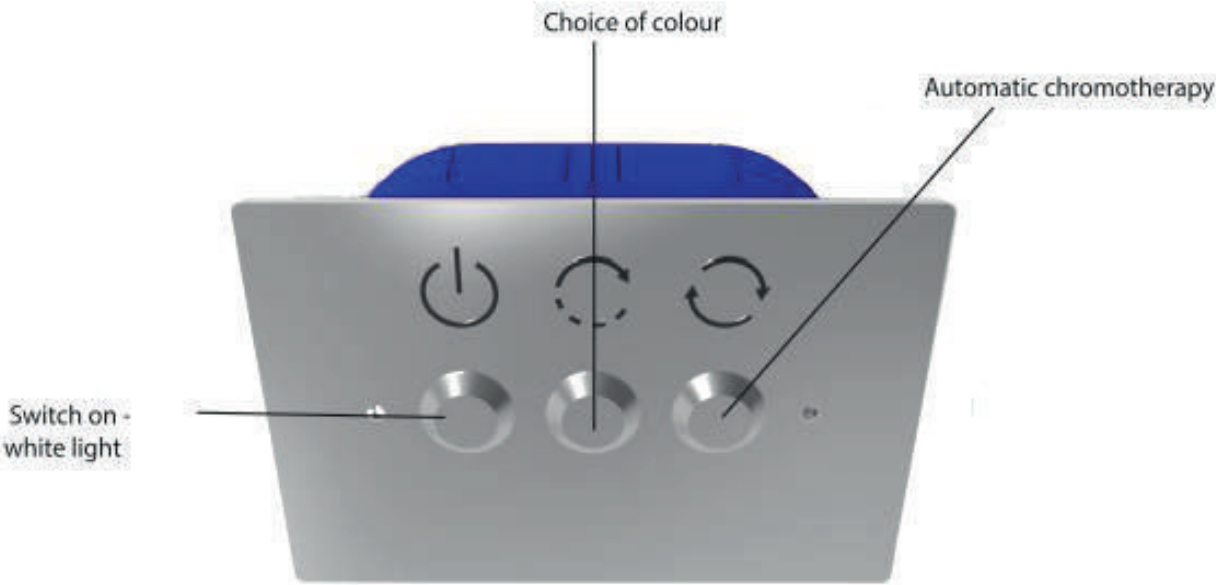

## **PRODUCT CARE - WARRANTY**

WARNING: THE INSURANCE DOES NOT COVER THE LIMESTONE'S DAMAGE AND DAMAGE CAUSED BY IMPURITIES.

The insurance does not cover the incorrect use of the equipment.

Recommendation of use:

- thoroughly flush the system before installing the equipment.
- periodically clean the nozzles from deposits of limestone.

### **CLEANING OF METAL PARTS**

Use soft cloth dampened with water and soap.

Wipe with a cloth the showerhead after use.

Advice:

- the installation of a filter system and a water softener extend the lifespan of this equipment.
- do not use alcohol, hydrochloric acid, phosphoric acid, bleach, chlorine and abrasive powder to clean.

The device has a two year warranty against manufacturing defects.

The warranty does not cover:

- different installation/use from what recommended in this instruction manual.
- the incorrect set up/installation of the water system.
- damages caused by limestone and water impurities.
- the use of improper cleaning materials.

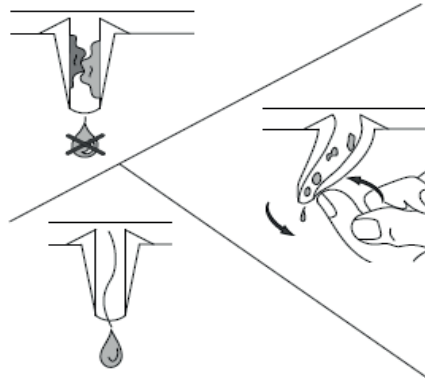

**ATTENTION**

Your shower head is equipped with silicone nozzles during normal use they may become clogged: for a proper cleaning is sufficient to act on the single obstructed nozzle, by performing with small finger rotations acts, to rid it of all impurities.

In the case of constant use in the shower, we recommend a monthly thorough cleaning.

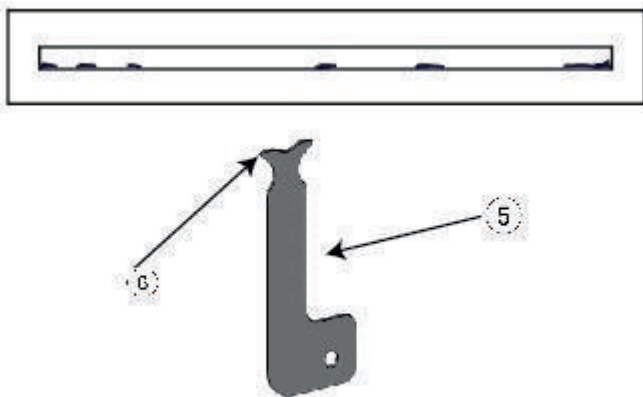

**TOOL FOR WATERFALL CLEANING**

If the flow of your waterfall is irregular/fragmented, it may have deposited over time some limescale due to frequent use of the product and/or water that is particularly hard or rich of limescale. Use the tool (5), inserting the tabs (6) in the spout of the cascade and moving horizontally (right and left) to remove any limescale.





LIVINGHOUSE.CO.UK

TEL: 01722 415000

EMAIL: SALES@LIVINGHOUSE.CO.UK

Unit 3 Ashfield Trading Estate ,  
Ashfield Road, Salisbury, SP2 7HL