

# QUBE WALL HUNG DESIGNER WASH BASIN (21C)

650MM SIZE

WEIGHT 16.5KG  
DIMENSIONS IN MM

---

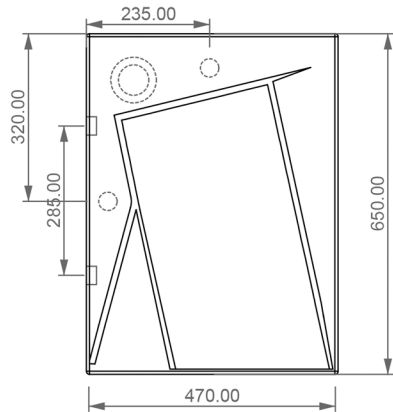

TOP

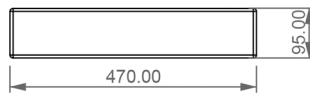

LEFT

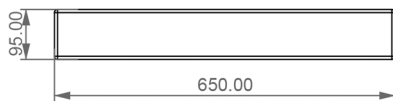

FRONT

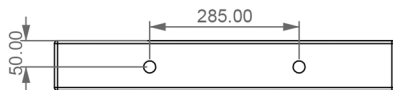

REAR

Ø45

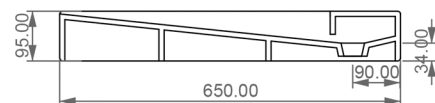

SECTION

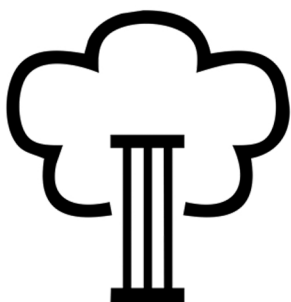
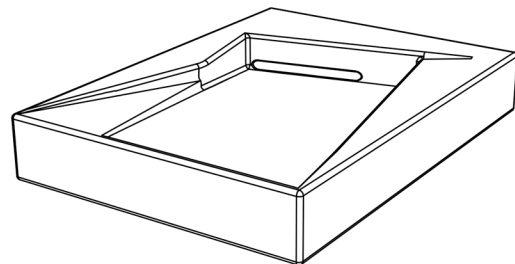

LIVINGHOUSE.CO.UK

N.B. Indicated size could have a variation of about 0,6% due to use of the moulds or the variations of the materials' technical characteristics used in the mixture.

TEL: 01722 415000

EMAIL: SALES@LIVINGHOUSE.CO.UK

# QUBE WALL HUNG DESIGNER WASH BASIN (21C)

950MM SIZE

WEIGHT 25.6KG  
DIMENSIONS IN MM

---

