



**THE MANUAL OF THE
ONE-PIECE INTELLIGENT TOILET**



1 SAFETY PRECAUTIONS

Please read this manual carefully before installation and strictly follow the instructions. After reading, please keep this manual in a prominent place. In order to avoid injury and property damage to users and others, please strictly observe the safety warnings and precautions.

⚠ WARNING Indicates that failure to comply with this warning may result in serious injury or death.

⚠ PAY ATTENTION Indicates that personal injury or property damage may be caused if the operation is not carried out in accordance with the provisions of this note.

SIGNS	⚠ WARNING
	Lit Cigarettes and other burning objects can not be put into the toilet bowl, otherwise it may cause a fire.
 FORBADE	<ol style="list-style-type: none"> Do not disassemble, repair or modify the product on your own, otherwise it may cause fire or electric shock. Do Not pour water or detergent on the body or plug, otherwise it may cause fire or electric shock. Do not use wet hands to plug or pull the plug, or you may get an electric shock. Do not use other electrical appliances in the same socket. Do not use extension cords or loose loose unstable power sockets, which may cause fire or electric shock. If the power cord is damaged, to avoid danger, it must be replaced by the manufacturer, its maintenance department or a professional from a similar department. This product is an electrical appliance and should not be exposed to water. Do Not Spray Urine or other liquids on the body. Do not use your fingers or other objects to plug the air outlet or you may get scalded, electrocuted or burned. When the product is energized, do not put the product on its side or upside down, otherwise it may cause fire or burn down.
 MUST BE OBEYED	<ol style="list-style-type: none"> Please do not install and use this product in the wet place such as the bathroom. This product must be reliably grounded, if not sure whether it has been reliably grounded, please let a qualified electrician or maintenance personnel check and confirm. Please ensure that the power outlet used by the product complies with the National Standard (zero or so fire) , can not be connected to the reverse. This product must be connected to AC220V / 50HZ, load current at least 10A special standard socket and wiring, and socket must, equipped with Earth fault breaker or earth leakage protector or similar high sensitive and fast leakage switch (rated sensitive current below 15mA) . The socket position should be installed in the place which is not easy to be dripped by water. It is suggested to use waterproof socket. <p>The installation should use the new hose assemblies and other attached or specified parts that come with the appliance. The old hose assemblies can not be reused, or they may cause water leakage, fire or electric shock.</p> <ol style="list-style-type: none"> When the product from the cold or wet place to move indoors, first placed 2 hours, so that the machine fully volatile condensate, and then boot to use, so as not to cause product short circuit. <p><small>Please note: When removing sticky labels, soften label with gentle warm heat and remove adhesive residue with label adhesive remover.</small></p>

SIGNS	⚠ WARNING
	Pull out the power plug when there is thunder. Do not place the product where it may fall into or be pulled into the bathtub or sink. Do not place product in water or other liquids. Do not touch products that have fallen into water or are immersed in water. Unplug the power plug immediately. Please do not stand on a ceramic toilet. The ceramic toilet must be fitted with anchor bolts. Do not use water other than tap water, or it may cause skin inflammation and other problems. Please do not let the sun direct irradiation products, so as to avoid product discoloration and affect the remote control reception effect. This product seat and cover has slow down function, please do not press hard, so as not to damage the slow down device. Do not apply force or impact. Do not stand on seat ring, cover or body. Do not place heavy objects. Do not use banana water, gasoline, lotions and detergents, pesticides, toilet cleaners and hard bristles to clean this product. Please stop using and cut off the power supply immediately when the product function is abnormal or malfunction, and contact the service provider in time.
 MUST BE OBEYED	When installing, disassembling, repairing and maintaining the product, you must unplug the power plug and close the water supply valve. If the room temperature is below 0 ° c, the water in the tank must be drained to prevent the tank from cracking. If it is not used for a long time, the power must be cut off and the water in the tank must be drained. People with physical, sensory, intellectual, or experience and lack of common sense (including children) need to use this product under the supervision of a special person. Do not let children play with this product. To prevent damage caused by freezing, please implement warm measures to raise the temperature of the toilet.

2 DAILY MAINTENANCE

BODY MAINTENANCE

- Please cut off the power when maintaining the body.
 - Please wipe the dirty area with a soft cloth wrung out of water.
 - Please power on the machine again after wiping.
- Warm tip: please do not use water to wash the surface of the product.

MAINTENANCE of NOZZLE

The dirt on the nozzle, according to the following methods maintenance: 1. When the human body is not seated, press the "hip wash" key or the "child wash / self clean" key of the remote control.

- Press the host "power" button or the remote control "stop" button to retract the spray Rod.

TIPS: Do not pull the spray rod, so as not to damage the spray rod and motor. The nozzle can be removed and cleaned separately.

3 INSTRUCTIONS for REMOTE CONTROL

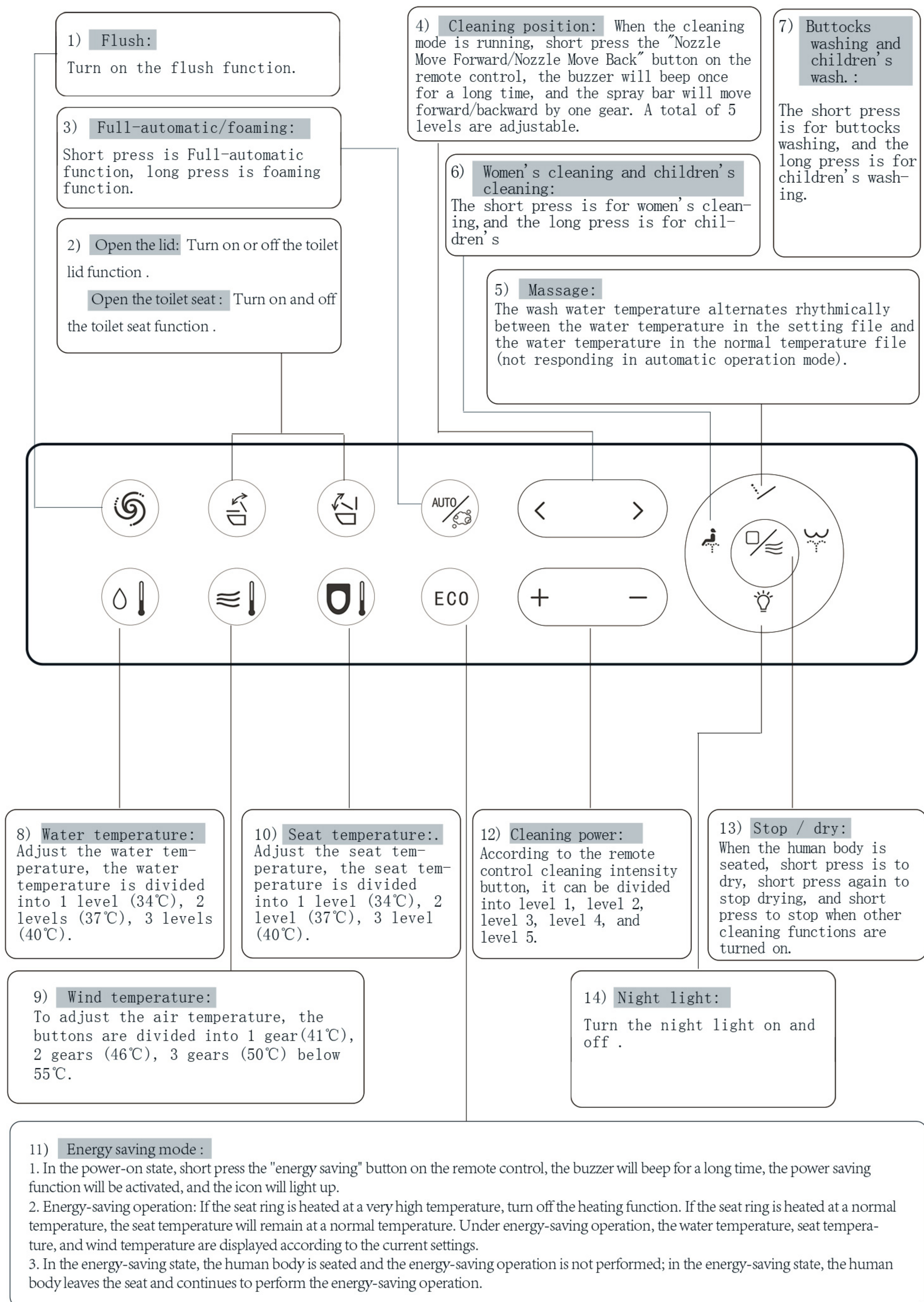

3 INSTRUCTIONS for REMOTE CONTROL

1. FLUSH: Long Press 5 seconds to adjust the flush mode, two clicks to open, one click to open (such as the current flush mode for drying while flushing according to the above operation can be adjusted to flush after leaving the seat) .

2. DRYING: the first operation of the remote control to start drying function for 3 minutes. Drying process again operation of this function is not responsive

3. HIP WASH: self-cleaning → mobile cleaning for 2 minutes → stop, the first operation for mobile remote control hip cleaning, the second operation for hip fixed cleaning for 2 minutes → stop.

4. CLEANING POSITIONG: in the cleaning mode operation, Short press the Remote Control "nozzle forward / nozzle backward" key, Buzzer Long 1 time, spray rod forward / backward shift a gear. 5 grades adjustable.

5. SEAT TEMPERATURE: adjust seat temperature, seat temperature is divided into 1(34 °C) , 2(37 °C) , 3(40 °C) .

6. WATER TEMPERATURE, regulate water temperature, water temperature is divided into 1(34 °C) , 2(37 °C) , 3(40 °C) .

7. ONE-BUTTON AUTOMATIC:the first time press this button for mobile cleaning, 2 minutes. Cleaning process again operation of this function for fixed cleaning and mobile cleaning switch.

8. FLIP/TURN : When the person is not seated, press and hold the flip button of the remote control for 5 seconds to turn on and off the microwave sensor function (one beep is on, two beeps are off)

9.ENERGY-SAVING:1. in the boot state, Short press the remote control "energy-saving" button, buzzer long sound, start energy-saving function, icon light. 2. energy-saving operation: If the seat ring is heated at very high temperature, turn off the heating function, if the seat ring is heated at room temperature, the seat temperature is maintained at room temperature. Under the energy-saving operation, the water temperature, the seat temperature and the air temperature are displayed according to the current settings. 83, in the energy-saving State, the human body into the seat energy-saving operation is not performed; in the energy-saving state, the human body from the seat, continue to perform the energy-saving operation.

FOAMING FUNCTION :The foaming function is completed when the person is seated, and the foaming time is 15 seconds. The foaming stops when any cleaning function or flushing function is operated during the foaming process. When the person is not seated, long press the power saver Press the key, long beep is foam on, short beep is foam off.

ICROWAVE FUNCTION: 1. The person will automatically flip the lid when approaching. After the lid is flipped, the microwave will sense someone's signal, and the lid will never fall.

2. Microwave distance adjustment, press the hot and cold massage button on the remote control to adjust the microwave induction distance, and judge the current gear according to the prompt sound.

3. When there is a microwave function, when the person is close to the microwave induction flip, the second foot feeling or remote control press the flip button is open, (the remote control press the flip button is closed). The third foot sense or remote control press the flip button is closed Circle (automatically close the lid and flush the water 2 minutes after the person leaves).

4. When there is no microwave function, press the flip button for the first foot feeling or remote control to open the cover, press the flip button for the second foot feeling or remote control to open the loop, and press the "turn circle" button for the third foot sense or remote control for Close the cover and close the ring and flush.

BREATH SCREEN FUNCTION: No signal is detected by the microwave and no function is used within 5 minutes, it will enter the screen off state. If there is any function under the screen off state, or the microwave sensor has a signal, the screen off state will be released and return to normal.

FLUSHING FUNCTION: The flushing methods include manual flushing (power off flushing), off-seat flushing, remote control flushing, and lid flushing. The flushing time setting can be adjusted for a short time or a long time. The adjustment method is in the shutdown state, long press the remote controller water temperature button, short beep for a short time, long beep for a long time. (In the event of a power failure, the memory time of the last flush before power failure is used). Use the sense of foot or press the flip button on the remote control. The lap opens and starts timing. After 2 minutes, the cap will automatically fall and the lap will automatically flush. If there is flushing within 2 minutes, the lid will automatically fall after 2 minutes, and the ring will not automatically flush.

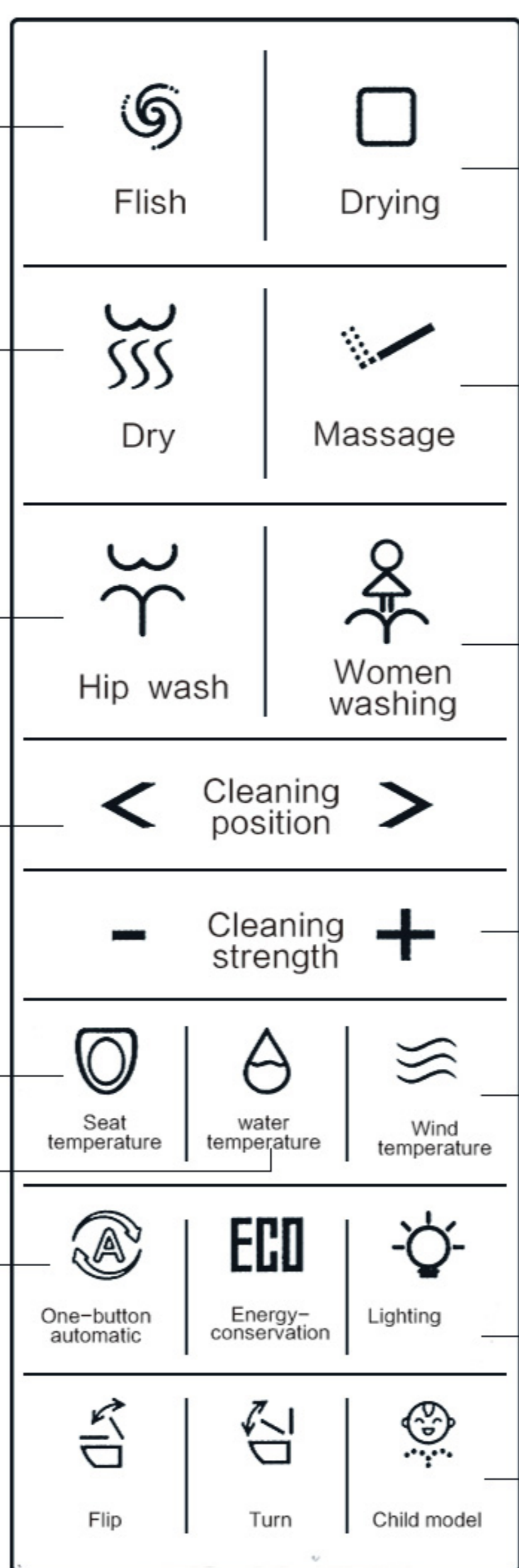

10. STOP: the remote control button to stop the current cleaning, drying function

11. MASSAGE: The temperature of the washing water alternates rhythmically between the water temperature of the set file and the water temperature of the normal temperature file (cannot respond in automatic operation mode) file and the water temperature of the normal temperature file (cannot respond in automatic operation mode)

12. WOMEN' S WASHING. Self-cleaning → Mobile cleaning for 2 minutes → Stop, the first operation of the remote control for female use is mobile cleaning, and the second operation is female fixed cleaning for 2 minutes → stop.

13. CLEANING STRENGTH: Press the remote control cleaning strength button to be divided into 1st, 2nd, 3rd, 4th, 5th.

14. WIND: TEMPERATURE: To adjust the wind temperature, the buttons are divided into 1 level (41°C), 2 levels (46°C), and 3 levels (50°C) below 55°C.

15. ILLUMINATION: In the power-on state, when the soft light is off, short press the buzzer for a long beep to turn on the soft light. When the soft light is on, short press the buzzer to make a long beep to turn off the soft light. Long press the setting knob light switch.

16. CHILD WASH: Self-cleaning → mobile cleaning for 30 seconds → drying for 1 minute → flushing, the first operation is mobile cleaning, the second operation is fixed cleaning and mobile cleaning switching When the child functions, the washing water pressure cannot be adjusted, and the water temperature and water pressure are 1 gear by default. During the function process, you can press the knob button and the remote control stop button to stop the fully automatic function.

4 Operating instructions for knobs

Forward KNOB (counter-clockwise rotation) → SELF-CLEANING → FEMALE MOBILE CLEANING FOR 2 minutes → drying for 3 minutes → stop, female fixed cleaning again counter-clockwise rotation for female fully automatic mobile cleaning, FEMALE MOBILE CLEANING AGAIN COUNTER-CLOCKWISE rotation for the female fully automatic fixed cleaning.

Drying stop: In other functional states, press the button to stop the function. In other states, press the button to dry the function. When the cover plate is cut off, the hand press the cover plate Knob to flush the water with the function of power off.

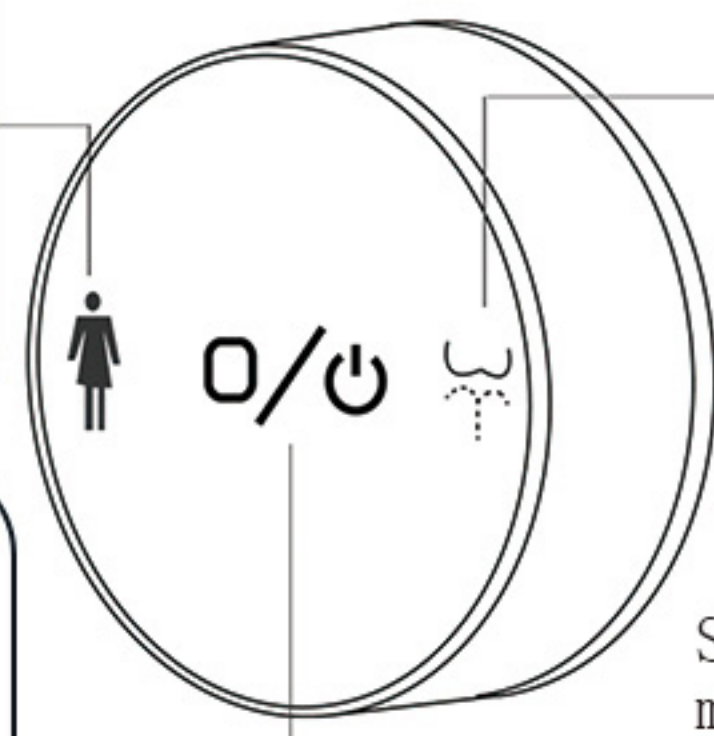

Forward KNOB (clockwise rotation) → self-cleaning → hip moving cleaning for 2 minutes → drying for 3 minutes → stop, hip fixed cleaning again clockwise rotation for the hip full automatic moving cleaning, when the buttock moves cleanses, rotates clockwise once more for the buttock full automatic fixed cleanses.

Status: Use Buttocks, children, hot and cold massage, fully automatic function for the blue, use for women when purple, when drying for red. People seated for the green often light, people seated for the white often light.

Manual flush function When the person is not seated, press the KNOB for flushing function.

Power switch When the person is not seated, press the 5-second button to stop the power switch for the toilet, repeat the operation can turn on the power (toilet power, switch when the display, knob, lighting, knob lights, microwave signal, foot signal to go out) .

Strength Adjustment of clamshell When a person is not seated, press the 5-second Knob to stop the power supply.

Within 3 seconds, press the flip button on the remote control, and the display will pop up to adjust the flip gear, then press the remote control on the cleaning force (a total of 11 files can be adjusted cycle of force) plus + to increase the force, minus- to reduce the force, after adjusting a long 5-second button to stop the power can be set successfully.

Turn-over adjustment When a person is not seated, press the 5-second Knob to stop the power supply. Within 3 seconds, press the turn-over button on the remote control. The display will pop up to adjust the turn-over gear, then press the remote control on the cleaning force (a total of 11 files can be adjusted cycle of force) plus + to increase the force, minus- to reduce the force, after adjusting a long 5-second button to stop the power can be set successfully.

MOISTENING function Once seated, it detected that the human body's seated signal turned on the moistening wall function (turn on the upper flush for 2 seconds) . The knob rotated in the direction of the female cleaning. After 5 seconds, it let go and then pressed the flush button on the remote control within 2 seconds, can Be turned on or off the toilet wall function. (after the seat from the seat less than or equal to 10 seconds of non-wetting wall, more than 10 seconds to re-wetting wall) , wetting function time 2 seconds.

5 Handling of frequently asked questions

	reason	Deal with
No squirting	Blockage caused by bending of intake hose;	Eliminate the bending of the intake hose;
	Inlet Valve closed;	Open the intake valve;
	Tap Water, no water	Waiting for water
Weak spouting	Partial blockage due to bending of intake hose;	The drain hose bends;
	Intake valve not fully open;	Fully open the inlet valve;
	Clogged Inlet strainer	Clean the inlet filter
The water is not hot	Water temperature set to room temperature;	Reset the water temperature gear;
	In standby or power-saving mode	Switch to function mode and spray after 2 minutes
Seat temperature is not hot	Set the seat temperature to normal;	Reset the setting temperature;
	In standby mode	Switch to function mode and spray after 2 minutes
The wind is not hot	Set the air temperature to room temperature	Reset the wind temperature gear
No Wind	In standby or power-saving mode	Switch to function mode to use the drying function
Spray Rod not retracted	Power cut;	Gently push the spray rod back and wait for incoming power;
	Stuck in a foreign object	removal
The boom doesn't extend out	Power cut;	Waiting for the call;
	Not Seated in the seat sensing area	Sit in the correct position. Sit in the sensing area
The remote doesn't show	Remote control battery positive and negative charge or low battery	Reload the battery and align the anode and cathode; Replace with a new battery
 Pay Attention	If the failure is not eliminated after handling according to the above method, the power should be cut off, contact the service provider, please professional maintenance. If the power leakage protection switch often jumps off, that the product has leakage, please cut off the power supply, contact the service provider, please professional maintenance.	

6 Other functions

Spray rod self-cleaning function The self-cleaning function will be opened at the beginning and the end of the cleaning (for the purpose of self-cleaning the spray rod and replacing the cold water in the pipe).

Automatic drop cover function 2 minutes after the person leaves the seat, the cover is automatically closed. When there is a microwave signal, when the microwave detects the signal of someone, the cover closing time will be automatically refreshed.

Memory program Water temperature, seat temperature, wind temperature, remote control setting gear before power off memory, spray rod shift memory last operation position.

7 Provision of water and electricity





1. Open the Angle valve for water and check the tightness of the threaded joint to ensure no water leakage.
2. Power cord leakage protection plug is inserted into the power socket, press the reset switch, the plug indicator light is on, indicating power on (press the leakage test button before the first use, and the protection switch pops up, indicating normal leakage protection function)
3. When the cover plate is powered on, the spray rod is extended and then returns, while spraying water from the clean mouth; when it returns to the position, the self-clean mouth stops spraying water, the floodlight is on during the reset process, and the floodlight is off after the reset (no flushing during the reset).

8 Technical indicators

The main machine	Rated Voltage	AC 220V/50HZ
	Rated power	1030W
	Maximum power	1670W / 1270W (auto-flip / slow-drop cover)
	Water pressure range	The minimum essential water pressure is 0.07 MPA (20L / Min flow rate) and the maximum water pressure is 0.8 MPA (hydrostatic pressure)
	Power Cord	It's about 1.5 meters long
	Water consumption	5L
Cleaning device	Heating Power	1600W
	Warm water temperature	Four-speed regulation
	Cleaning flow	Five-speed regulation
	Cleaning mode	Hip Wash / mobile massage, woman wash / mobile massage
	Spray position	Five-speed regulation
	Hydraulic protection	Pressure stabilizing device and automatic pressure releasing device
	Antifouling device	Water discharge device, nozzle automatic cleaning device, anti-siphon device, anti-backflow device, filter device
Drying apparatus	Safety device	temperature sensor, overheat preventer, Thermal cutoff, earth protection, Earth leakage protection, anti-air burning device
	Warm wind speed	Greater than 4 meters per second.
	Warm Air	Four-stage regulation
	Heating Power	250W
Insulating seat ring	Safety device	Temperature sensors, overheat preventers, Thermal cutoff
	Surface temperature	Four-stage regulation
	Heating Power	50W
	Opening and closing device	Mute or auto-flip
	Prevent low temperature scald	After using for 10 minutes, the seat temperature is lowered to low gear automatically
Sweet setup	Safety device	Sitting Sensor, temperature sensor, overheat preventer, Thermal cutoff
	Night light setup	Intelligent, always out, always bright
	User Code Setting	One machine, one code, to prevent the use of multiple products multiple users, mutual interference
	Liquid Crystal Display device	Real-time display of water temperature, seat temperature and wind temperature
	Deodorizer	Electro-catalytic deodorization
	Foot flush function	Close to the foot feel button, start the flushing function (slowly lower the cover plate)
	Feel the feet turn over function	Close to the foot button, automatically open / turn over the seat ring (automatically flip over)
	Microwave auto-flip function	Close to the front of the toilet, automatically open the lid, after leaving, automatically close the lid and automatically flush (automatic flip)
	Product Implementation Standard	Comply with national and industry standards

1 Cautions for safety. Please observe the following rules.

**The following symbols are used to indicate important safety instructions for the use of the product.

	Danger	Indicates an imminently hazardous situation which, if not avoided, will result in death or serious injury.
	Warning	Indicates dangerous situations where the user could suffer death or serious injury if this product is used incorrectly.
	Do not dismantle	Indicates not to dismantle this product.
	Observe strictly	Indicates to observe the following precaution before using this product.

- ★ **Tip:** When you have multiple smart toilets, set them to different channels for remote control.
- Setting channel steps:**
1. Please plug in the toilet.
 2. Press the STOP button on the toilet panel, hold down the button.
 3. Meanwhile press MALE CLEANING button to change the channel.
 4. There are 8 channels for you to choose, you can hear different beep on different channels. Choose one of them.
 5. Take out the remote control, hold down the two buttons "←" and "→" until hearing the beep, release the buttons immediately. Channel setting is complete.

★ **Note:** Press the "CHOOSE" button for 3 seconds to open or close the motion sensor.

Accessories



Water shutoff valve



Constant pressure valve



Battery box



Remote control

2 Install the Battery box

Put the battery in the battery box, then connect the Battery box to the toilets.

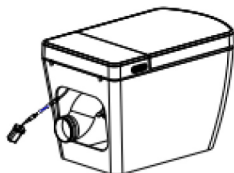

3 P-trap installation

Adjust the position of the toilet drain outlet, and then connect the toilet to the wall.

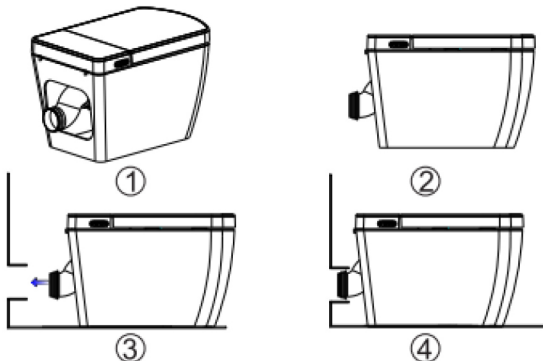

4 Install shutoff valve

1. Close the main water supply
2. Wind Teflon tape around water shutoff valve
3. Connect the shutoff Valve, tighten up with wrench.
4. Connect the constant pressure valve.

Note: After installing the shutoff Valve, please turn on the water supply and Valve to flush the dirt for 30s and check whether there is a leakage.

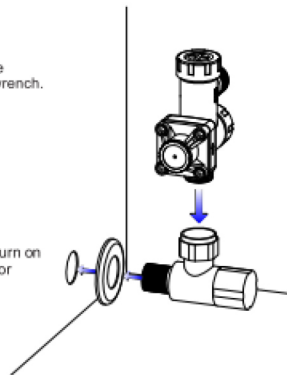

5 Connect the hose

Fix the hose to the Constant pressure valve

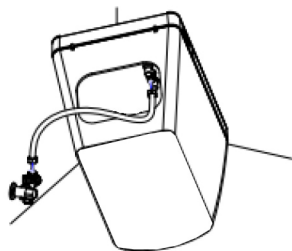

6 Apply glass glue.

1. Flush the toilets and find whether there is a leakage with a paper.
2. Water may get into the part between the lower end of the toilet and the floor and leave stain. Apply glass glue (Not Concrete) to prevent water penetration.

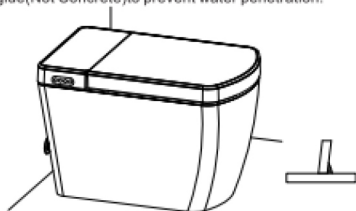

7 Connect Power

1. Insert the power plug into the outlet
2. Turn on the shutoff valve.
3. Press the flush button on the remote control to do a test.

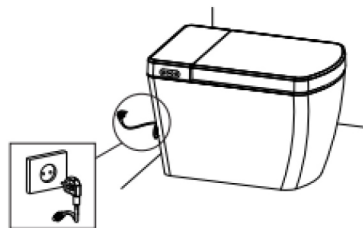
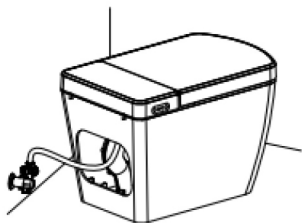

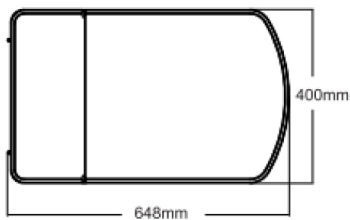
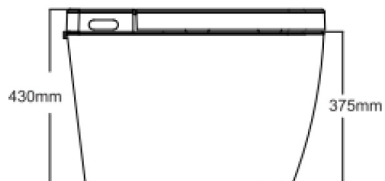

Wall drain P-Trap

